

Projecteur Portatif LED COB 10-30 watts

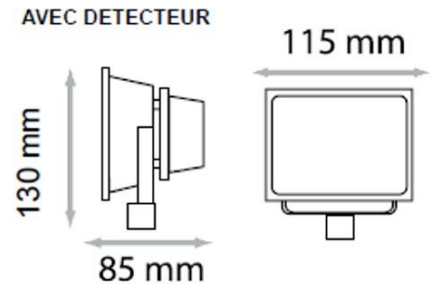

REF	Puissance absorbée	Lumens	IP	Couleur	Dimmable	Tension	équivalence
MI-8050	10 watts	900	65	3000°K	Non	230 volt	95 watts
MI-80501	10 watts	900	65	6000°K	Non	230 volt	95 watts
MI-8051N	10 watts	900	65	3000°K	Non	230 volt	95 watts
MI-80502	30 watts	1600	65	6000°K	Non	230 volt	95 watts

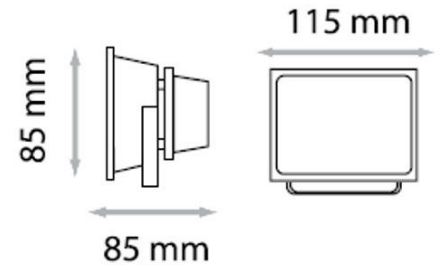





Projecteur LED COB 10 watts





Réf. 8010
Télécommande
Radio Fréquence

Réf. 8010I
Télécommande
Infrarouge









AC
 230 volt



 Phase / Neutre
 Terre

COB

10 watts

30 watts



112°

Non Dimmable

REF	Puissance absorbée	Lumens	IP	Couleur	Dimesions (LxPxH mm)	Tension	Couleur produit
MI-8001	10 watts	900	65	6000°K	115x85x85	230 volt	Gris
MI-8006	10 watts	860	65	3000°K	115x85x85	230 volt	Gris
MI-8010	10 watts	860	65	RGB	115x85x85	230 volt	Gris
MI-8010I	10 watts	860	65	RGB	115x85x85	230 volt	Gris
MI-8030	10 watts	900	65	6000°K	115x85x130	230 volt	Gris
MI-8036	10 watts	860	65	3000°K	115x85x130	230 volt	Gris

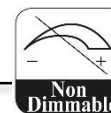
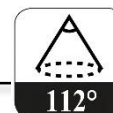
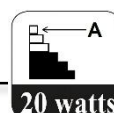

Projecteur LED COB 20 watts



REF	Puissance absorbée	Lumens	IP	Couleur	Détecteur	Tension
MI-8042	20 watts	1800	65	6000°K	Non	230 volt
MI-8043	20 watts	1680	65	3000°K	Non	230 volt
MI-8044	20 watts	1680	65	RGB	Non	230 volt
MI-8031	20 watts	1800	65	6000°K	Oui	230 volt
MI-8037	20 watts	1680	65	3000°K	Oui	230 volt

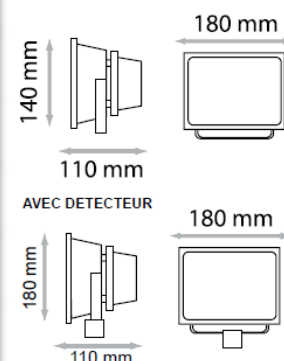

Projecteur LED COB 30 watts

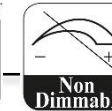
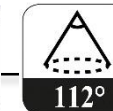
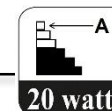
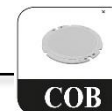

REF	Puissance absorbée	Lumens	IP	Couleur	Détecteur	Tension
MI-8002	30 watts	2700	65	6000°K	Non	230 volt
MI-8007	30 watts	2560	65	3000°K	Non	230 volt
MI-8011	30 watts	25600	65	RGB	Non	230 volt
MI-8032	30 watts	2700	65	6000°K	Oui	230 volt
MI-8038	30 watts	2560	65	3000°K	Oui	230 volt

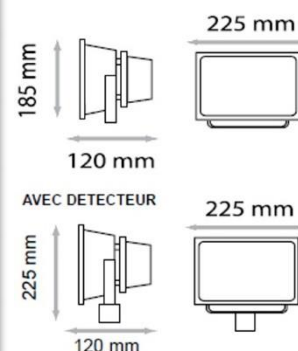

Projecteur LED COB 50 watts

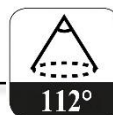
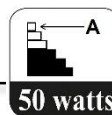

REF	Puissance absorbée	Lumens	IP	Couleur	Détecteur	Tension
MI-8003	50 watts	4500	65	6000°K	Non	230 volt
MI-8008	50 watts	4280	65	3000°K	Non	230 volt
MI-8012	50 watts	4280	65	RGB	Non	230 volt
MI-8033	50 watts	4500	65	6000°K	Oui	230 volt
MI-8039	50 watts	4280	65	3000°K	Oui	230 volt

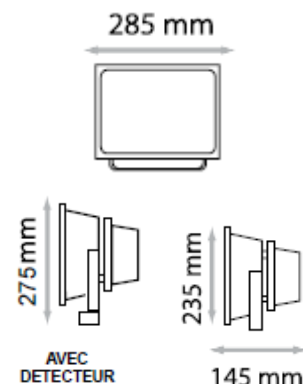

Projecteur LED COB 80-100 watts



REF	Puissance absorbée	Lumens	IP	Couleur	Détecteur	Tension
MI-8004	80 watts	7200	65	6000°K	Non	230 volt
MI-8009	80 watts	6840	65	3000°K	Non	230 volt
MI-8013	80 watts	/	65	RGB	Non	230 volt
MI-8034	80 watts	7200	65	6000°K	Oui	230 volt
MI-8040	80 watts	6840	65	3000°K	Oui	230 volt
MI-8045	100 watts	9085	65	6000°K	Non	230 volt
MI-8046	100 watts	8358	65	3000°K	Non	230 volt
MI-8047	100 watts	/	65	RGB	Non	230 volt
MI-8035	100 watts	9085	65	6000°K	Oui	230 volt
MI-8041	100 watts	8358	65	3000°K	Oui	230 volt

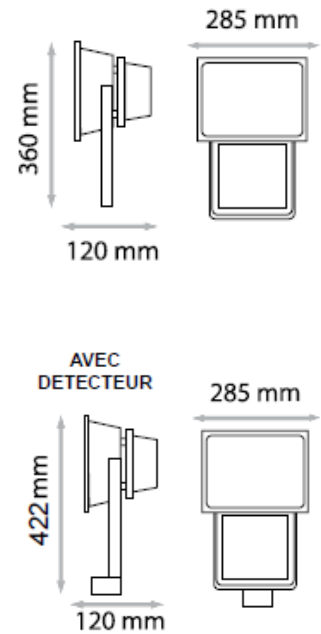

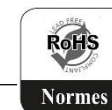

Projecteur LED COB 80-100 watts

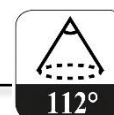
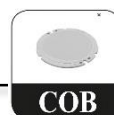

Projecteur Gris LED COB

REF	Puissance absorbée	Lumens	IP	Couleur	Couleur produit	Tension	Dimension LxPxH mm
MI-80011	10 watts	900	65	6000°K	Gris	230 volt	170x60x200
MI-80421	20 watts	1800	65	6000°K	Gris	230 volt	280x80x310
MI-80021	30 watts	2700	65	6000°K	Gris	230 volt	280x80x310
MI-80031	50 watts	4500	65	6000°K	Gris	230 volt	325x113x375
MI-80041	80 watts	7200	65	6000°K	Gris	230 volt	380x130x470
MI-80451	120 watts	10800	65	6000°K	Gris	230 volt	380x130x470

Projecteur Noir LED COB

REF	Puissance absorbée	Lumens	IP	Couleur	Couleur produit	Tension	Dimension LxPxH mm
MI-80011N	10 watts	900	65	6000°K	Noir	230 volt	170x60x200
MI-80421N	20 watts	1800	65	6000°K	Noir	230 volt	280x80x310
MI-80021N	30 watts	2700	65	6000°K	Noir	230 volt	280x80x310
MI-80031N	50 watts	4500	65	6000°K	Noir	230 volt	325x113x375
MI-80041N	80 watts	7200	65	6000°K	Noir	230 volt	380x130x470
MI-80451N	120 watts	10800	65	6000°K	Noir	230 volt	380x130x470

Projecteur LED COB 80-100 watts

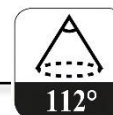
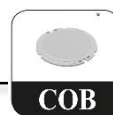

Projecteur Blanc LED COB

REF	Puissance absorbée	Lumen s	IP	Couleur	Couleur produit	Tension	Dimension LxPxH mm
MI-80011B	10 watts	900	65	6000°K	Noir	230 volt	170x60x200
MI-80421B	20 watts	1800	65	6000°K	Noir	230 volt	280x80x310
MI-80021B	30 watts	2700	65	6000°K	Noir	230 volt	280x80x310
MI-80031B	50 watts	4500	65	6000°K	Noir	230 volt	325x113x375
MI-80041B	80 watts	7200	65	6000°K	Noir	230 volt	380x130x470
MI-80451B	120 watts	10800	65	6000°K	Noir	230 volt	380x130x470